

PRODUCT CODE: SR10G
EXTENSION RING

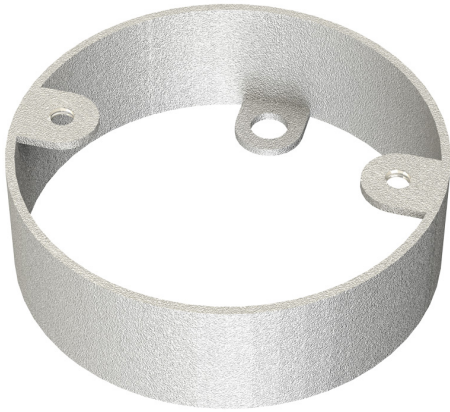

DESCRIPTION

10mm Extension Ring

FINISH

BZP

MATERIAL

Steel

PACKAGING

Packed in qty 50

ADDITIONAL NOTES

Conforms to BS EN61386-1

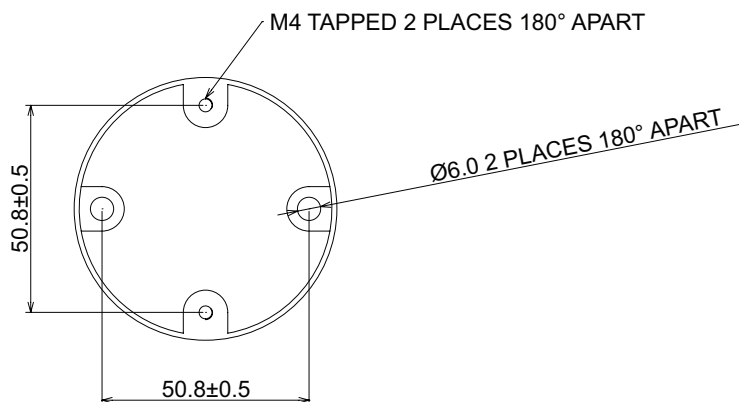
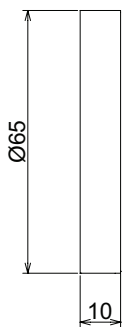
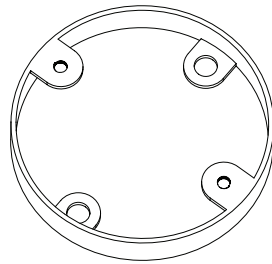

Values are nominal and with a general tolerance $\pm 5\%$ unless otherwise specified